

---

# Testing Advisory Group #3

## 16 March 2022

## Agenda

#	Item	Objective	Type	Lead	Time	Page
1	<b>Welcome</b>			Chris W	10:00-10:05 <i>5 mins</i>	
2	<b>Minutes, Actions and Relevant Information</b>	<ul style="list-style-type: none"> <li>• Approve February minutes. Update on open actions, closing where appropriate.</li> <li>• Sign-post relevant deliverables and content</li> </ul>	Decision  Information	Chris W	10:05-10:10 <i>5 mins</i>	
3	<b>Governance Group Updates</b>	Provide updates from L2 and L3 Governance Groups (PSG, DAG and CCAG)	Information	Programme (PMO)	10:10-10:15 <i>5 mins</i>	
4	<b>TAG Governance: DWG, MWG and TMAG</b>	<p>Provide updates on migration planning under the TMAG and standing up the MWG in April (action TAG02-03)</p> <p>Approve new versions of ToR:</p> <ul style="list-style-type: none"> <li>• TMAG ToR (action TAG02-02)</li> <li>• DWG ToR (action TAG 02-08)</li> </ul>	Information  Decision	Adrian A	10:15-10:30 <i>15 mins</i>	
5	<b>E2E Test Strategy</b>	Review and agree Test Strategy principles as presented	Discussion	Kate G	10:30-11:25 <i>55 mins</i>	
6	<b>E2E Test Data Strategy</b>	Update from DWG on the timelines for Data Strategy development and sign off (action TAG 02-08)	Discussion	Kate G	11:25-11:35 <i>10 mins</i>	
7	<b>Summary and next steps</b>	Summarise actions and plan agenda for next meeting	Information	Chris W	11:35-11:40 <i>5 mins</i>	

# Minutes, Actions and Relevant information

- Approve February minutes. Update on open actions, closing where appropriate. (decision)
- Sign-post relevant deliverables and content (information)

Chris Welby

*5 mins*

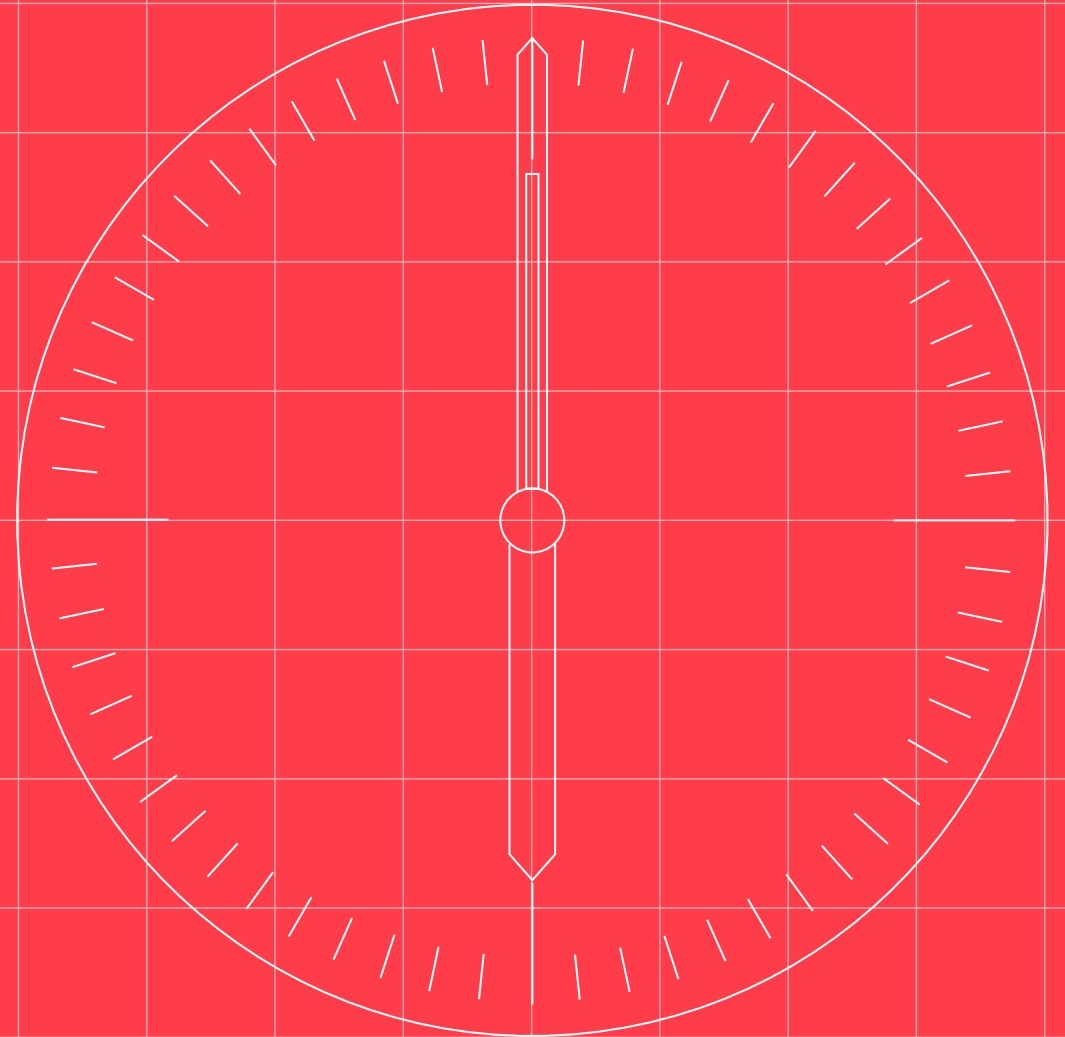

## Minutes and Actions Review. Deliverables Highlights

### 1. Approval of [TAG002 Minutes from 16/02/22](#)

### 2. Open Actions and Actions from TAG002 16/02/22:

Ref	Date	Action	Owner	Due Date	Status
TAG01-03	26/01/2022	Propose an approach for TAG members to be able to access M5 deliverables of interest.	Programme	16/03/2022	PROPOSAL TO CLOSE: following discussion at February TAG
TAG02-01	16/02/2022	Address ToR comments received just prior to meeting and circulate latest ToR for approval ex-committee	Adrian A	16/03/2022	PROPOSAL TO CLOSE: Comments addressed by the Programme, with no follow up received or changes to ToR required
TAG02-02	16/02/2022	Update TAG ToR to reflect change to Testing and Migration Advisory Group (TMAG) for review by members	Adrian A	16/03/2022	PROPOSAL TO CLOSE: Circulated alongside meeting papers for approval – agenda item 4
TAG02-03	16/02/2022	Define what migration means, what the remit of the Migration Working Group is, and implications for TMAG	Kate G	16/03/2022	PROPOSAL TO CLOSE: For discussion – agenda item 4
TAG02-04	16/02/2022	Programme to schedule discussion session with DCC, Elexon, and registration service providers to discuss testing timelines, sequencing, and resource requirements, and determine impacts on MHHS Testing Strategy	Kate G	16/03/2022	OPEN: To be scheduled 17 <sup>th</sup> /18 <sup>th</sup> March. Email requesting availability has been shared with relevant TAG members
TAG02-05	16/02/2022	TAG members to provide any views on programme milestones as part of the replan consultation	TAG Members	18/05/2022	OPEN: Ongoing
TAG02-06	16/02/2022	Programme to discuss governance of PIT and SIT with DCC	Kate G	16/03/2022	OPEN: Scheduled for 15 <sup>th</sup> March
TAG02-07	16/02/2022	TAG members to provide any comments on the proposed test phases and stages no later than close of business 25 February 2022	TAG Members	25/02/2022	PROPOSAL TO CLOSE: No comments received to PMO. Agenda item 5 for discussion
TAG02-08	16/02/2022	Schedule Data Working Group for 3 March 2022 and seek members via programme channels	PMO	03/03/2022	CLOSED: First DWG held w/c 28/02. Update to be provided in agenda item 6

### 3. Relevant content for TAG members, March 2022

- Relevant updates for this month will be shared as part of governance group update agenda item

# Governance Group Updates

Provide updates from L2 and L3 Governance Groups (PSG, DAG and CCAG) (information)

Programme PMO

*5 mins*

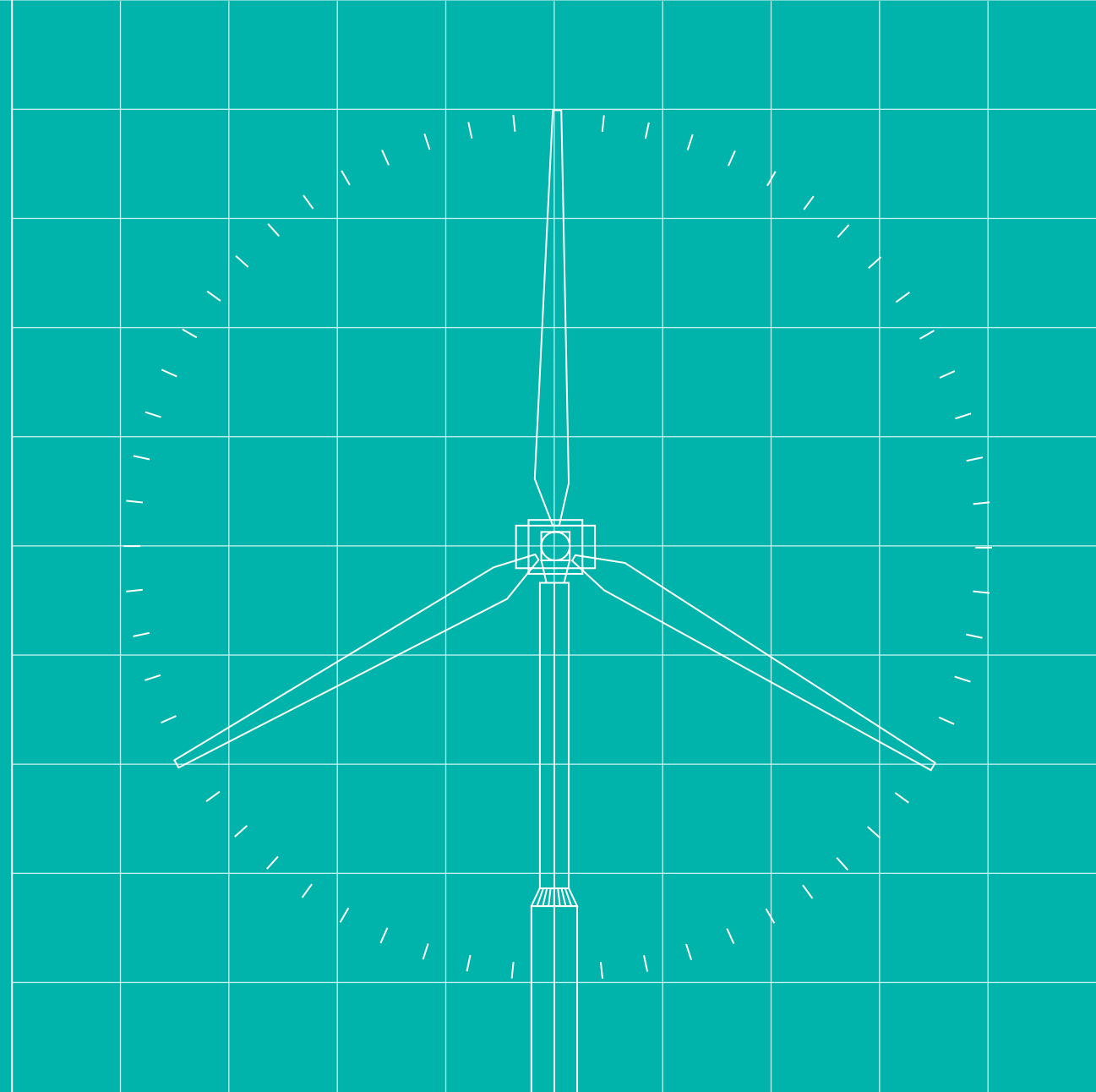

### PSG

#### Update from PSG 03 March 2022

1. The **Independent Programme Assurer (IPA)** provided an overview of their team, role, objectives and framework
2. The Programme presented a **plan for resolving the Supplier Plan Delay Proposal**. This included two possible scenarios to raise as Change Requests: a compromise delay to July or the original supplier delay. An extraordinary PSG has been scheduled for 11 March to review and progress any Change Request(s)
3. The Programme presented the **Programme Change Control process** for feedback. Next steps are to review with the IPA and Ofgem
4. The Programme presented **Programme Cooperation Principles and Ways of Working**, to be raised as a Change Request to update the MHHS Governance Framework
5. A new version of the **MHHS Governance Framework** was approved

### CCAG

#### Update from CCAG 23 February 2022

1. Ofgem provided an update on the **Smart Meter Act Powers** and implications for MHHS, such as how the Powers work, timeframes for implementation, and how this will impact MHHS code changes
2. The CCAG discussed the current **plan for M6 and M8** and the steps required to submit a Change Request. The CCAG reviewed a straw man plan to M8 to develop further into a Change Request
3. The CCAG reviewed **assumptions** submitted by each Code Body, to add to the RAID Framework
4. The CCAG reviewed the **MHHS Programme Code Change Horizon Scanning Log**

### DAG

#### Agenda items for DAG 09 March:

1. **Updates are to be provided** on the following areas for DAG feedback:
  - a) Updates to the **DAG ToR** to reflect feedback in February
  - b) Next steps on a solution for the **Level Playing Field Principle**
  - c) Updated **high level design principles** from February feedback
  - d) Updated **TDWG design principles and Technology/Architecture Characteristics** from February feedback
2. The DAG will seek to make a decision on **Integration Platform decisions**
3. Updates will be provided on **L4 Working Groups and design workstream forward plan**

# TAG Governance: TMAG, DWG and MWG

Provide updates on migration planning under the TMAG and standing up the MWG in April (action TAG02-03) (information)

Approve new versions of ToR (decision)

- TMAG ToR (action TAG02-02)
- DWG ToR (action TAG 02-08)

Kate Goodman/Adrian Ackroyd

*15 mins*

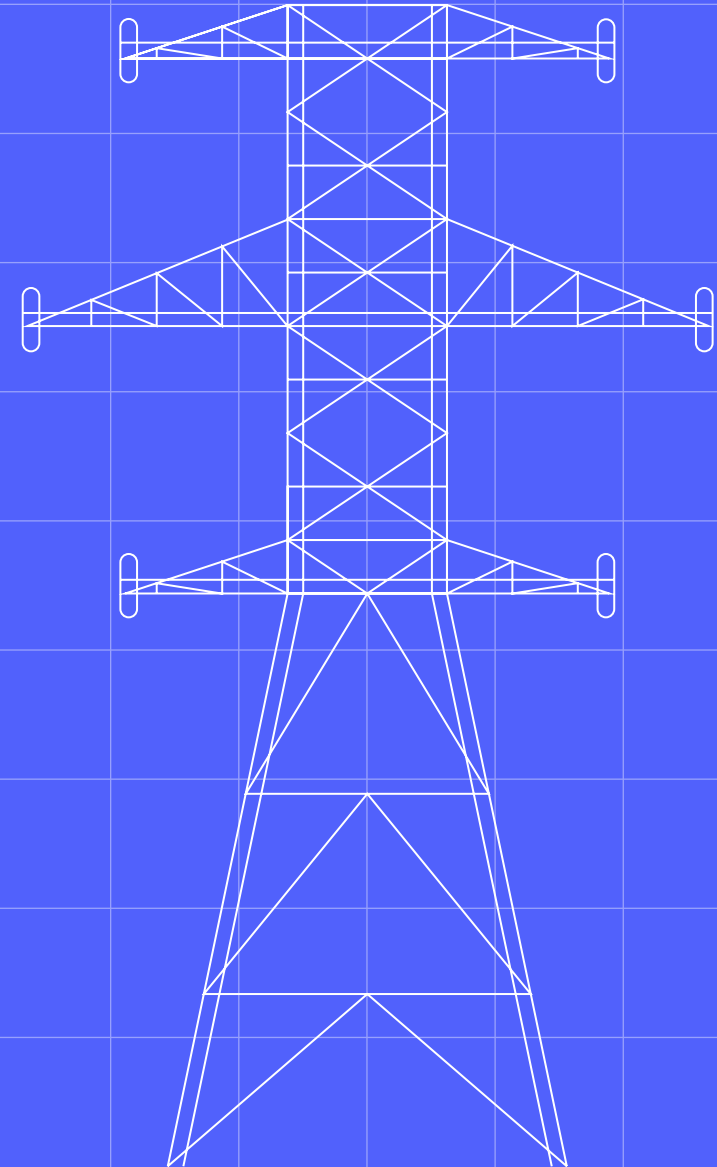

# E2E Testing Strategy

Review and agree Test Strategy principles as presented (discussion)

Kate Goodman/Adrian Ackroyd

*55 mins*

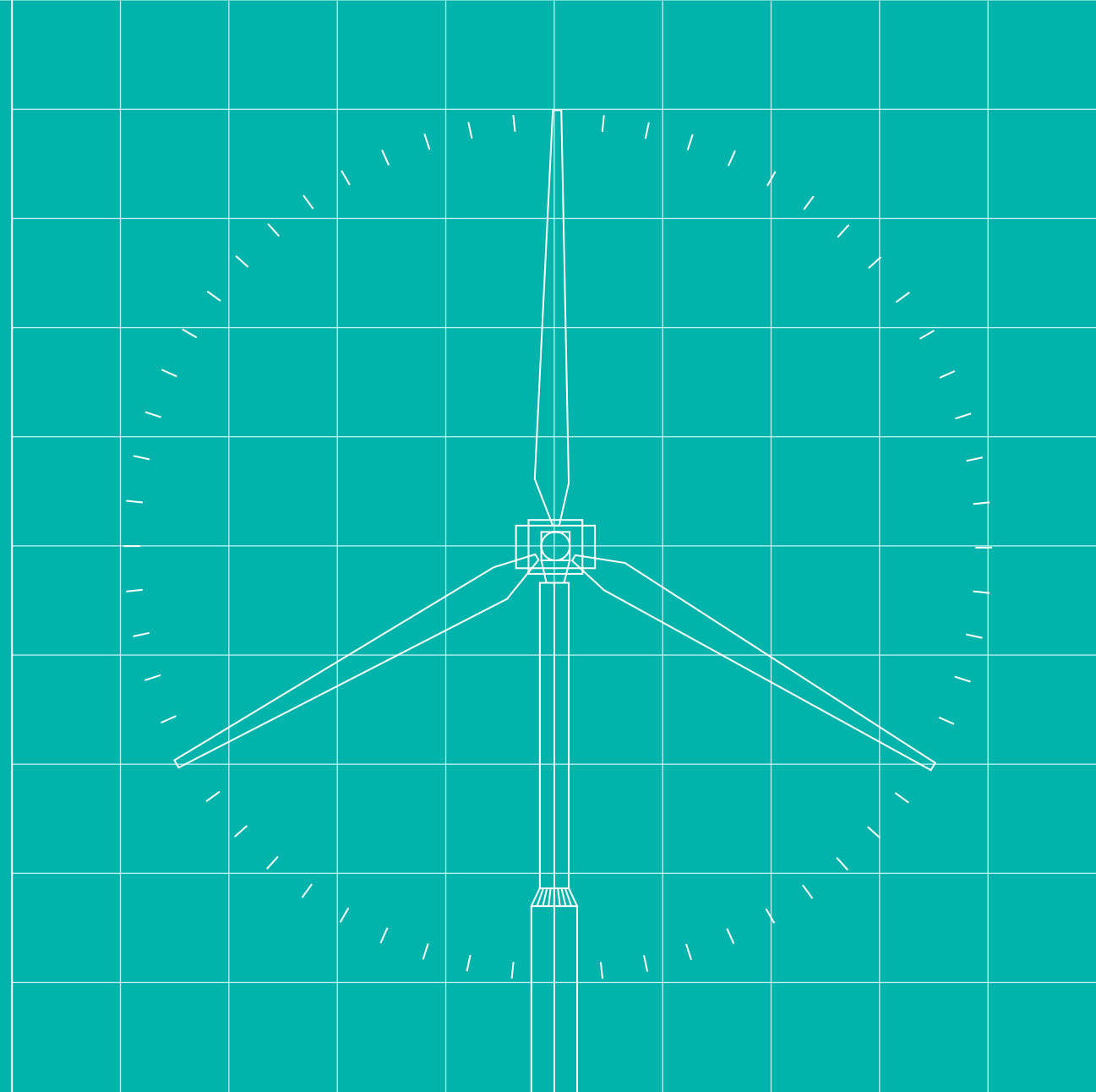



To agree the integration & testing strategy  
as described in these slides

...and as amended by the agreements  
reached in the TAG meeting

...such that the strategy can then be further  
elaborated in the draft Word document

# Process for producing & reviewing Strategy

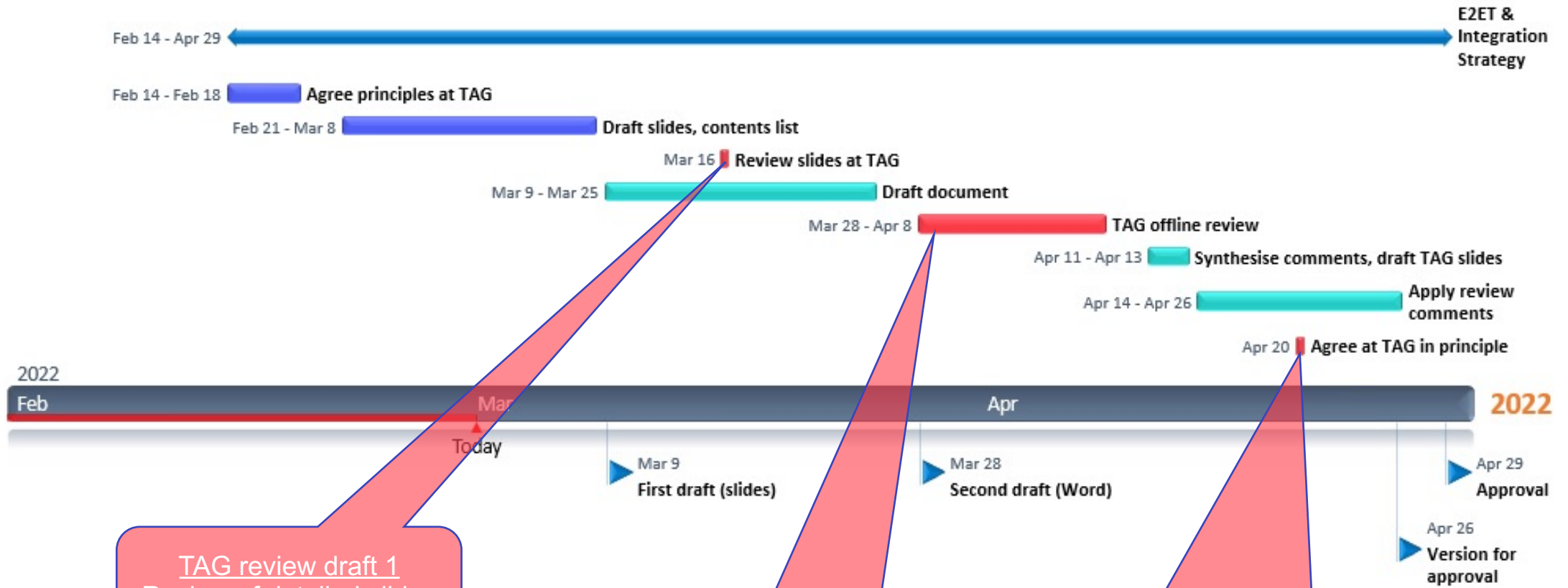

TAG review draft 1  
Review of detailed slides (this pack) at TAG

Members review draft 2 individually  
10 WD review of Word document (based on slides & TAG input)

TAG agree in principle  
Agree on resolution of major comments  
Agree that document can be approved offline if all other comments are addressed

## Table of Contents

- **Introduction**
- **Scope & Objectives**
  - Test Phases and Stages
- **Pre-Integration Testing**
  - Purpose & scope
  - Inputs & outputs
  - Entry & exit
- **Systems Integration Testing**
  - Component Integration
    - Purpose & scope
    - Inputs & outputs
    - Entry & exit
  - Functional...
  - Non-Functional...
  - Migration...
  - Operational...
- **User Integration Testing**
  - Qualification
    - Purpose & scope
    - Inputs & outputs
    - Entry & exit
  - E2E Sandbox...
- **Test Governance & Reporting**
- **Test Environments & Configuration Management**

- **Simulators, Emulators & Data Generator Test Harnesses**
- **Test Process**
  - Prioritisation
  - Coverage
  - Pass & fail
- **Test Management & Organisation**
  - PIT
    - Preparation
    - Execution
    - Reporting
    - RACI
  - SIT
  - UIT
- **Test Assurance**
  - Assurance activities
  - Quality Gates
  - Entry & exit criteria
  - Test traceability
- **Defect & Issue Management**
  - Approach
  - Process & tools
  - Governance
  - Reporting
- **Risks, Assumptions & Dependencies**

Note that this slide shows the contents list for the final Word document

This slidepack covers most (but not all) of the items in this ToC

# Overall Test Scope

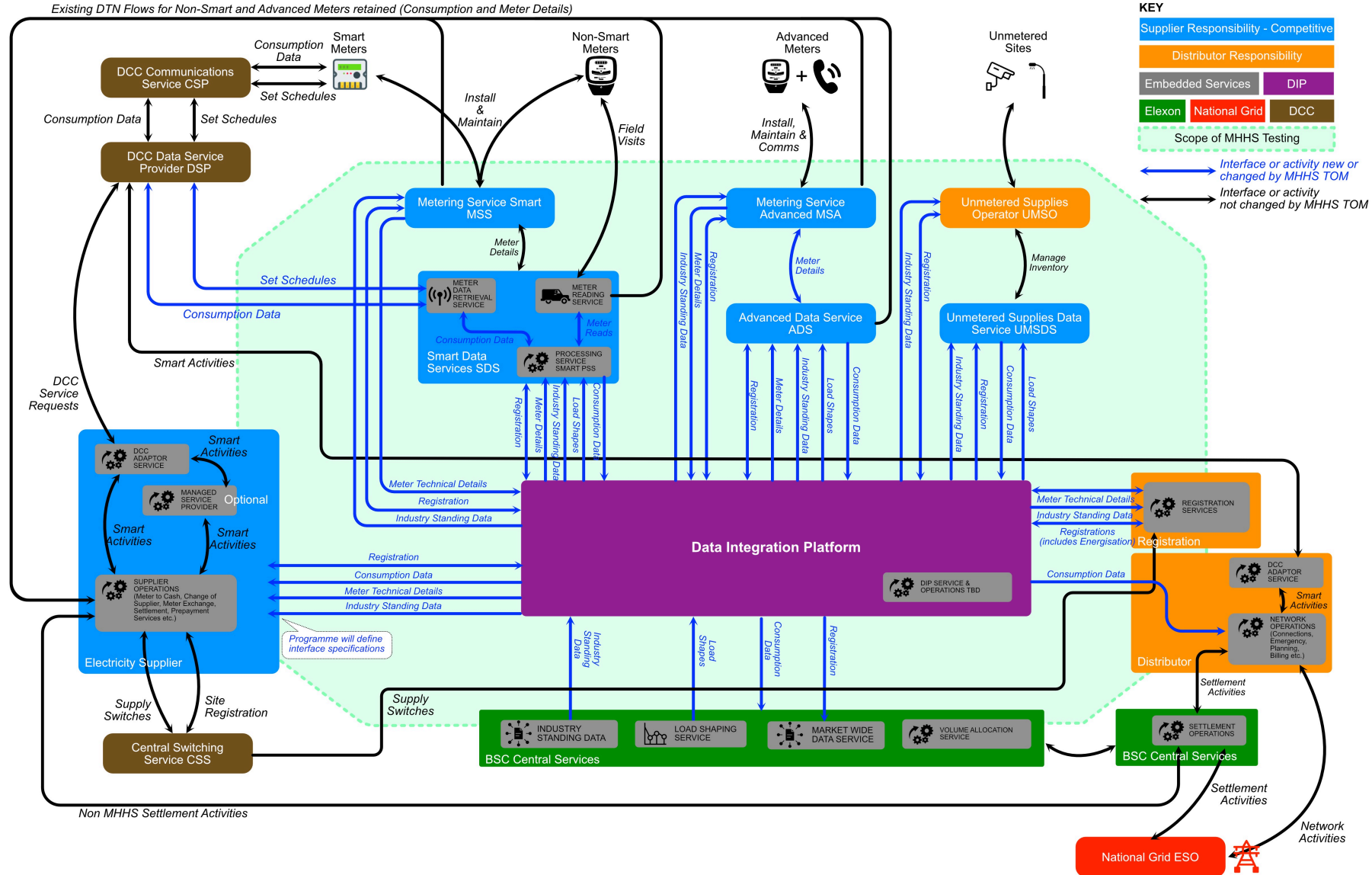

**Scope of MHHS testing is shown in the light green octagon**

Note that where the scope partially covers a component (eg BSC Central Systems), the interfaces to/from that component are within the scope of testing. Testing that the component acts correctly in the context of MHHS E2E testing is also within scope (for example, for LSS, when a certain data set is input from SDS, that the LSS produces an output which is consumable by SDS and is correct).

Verification of the detailed functionality of the component is however not in the scope of MHHS and is the responsibility of the component's service provider.

# Test Phases & Stages

Phase	Stage	Purpose (verifies that...)	Under test	Involved
Pre-Integration Test (PIT)	Pre-Integration	Systems work as designed when running in a standalone manner	PP's own systems	
Systems Integration Test (SIT)	Component Integration			
	DIP	Systems integrate as designed	DIP, Elexon Central Systems, Meter Services, Registration Services, DCC, DTN, Data Services	
	Central Systems			
	Data Services			
	Meter / Registration Services, DCC, DTN, Supplier Services			
	Functional	Systems support full E2E business processes		
	Operational	Systems support full operational processes		
	Non-Functional	Systems' NF characteristics are as designed		
	Migration	Migration processes give correct business outcome		
	User Integration Test (UIT)	Qualification	Systems support requirements for qualification	PP's own systems
E2E Sandbox		Systems support full business & operational processes		

# Test Phases & Stages - Dependencies

## Phase

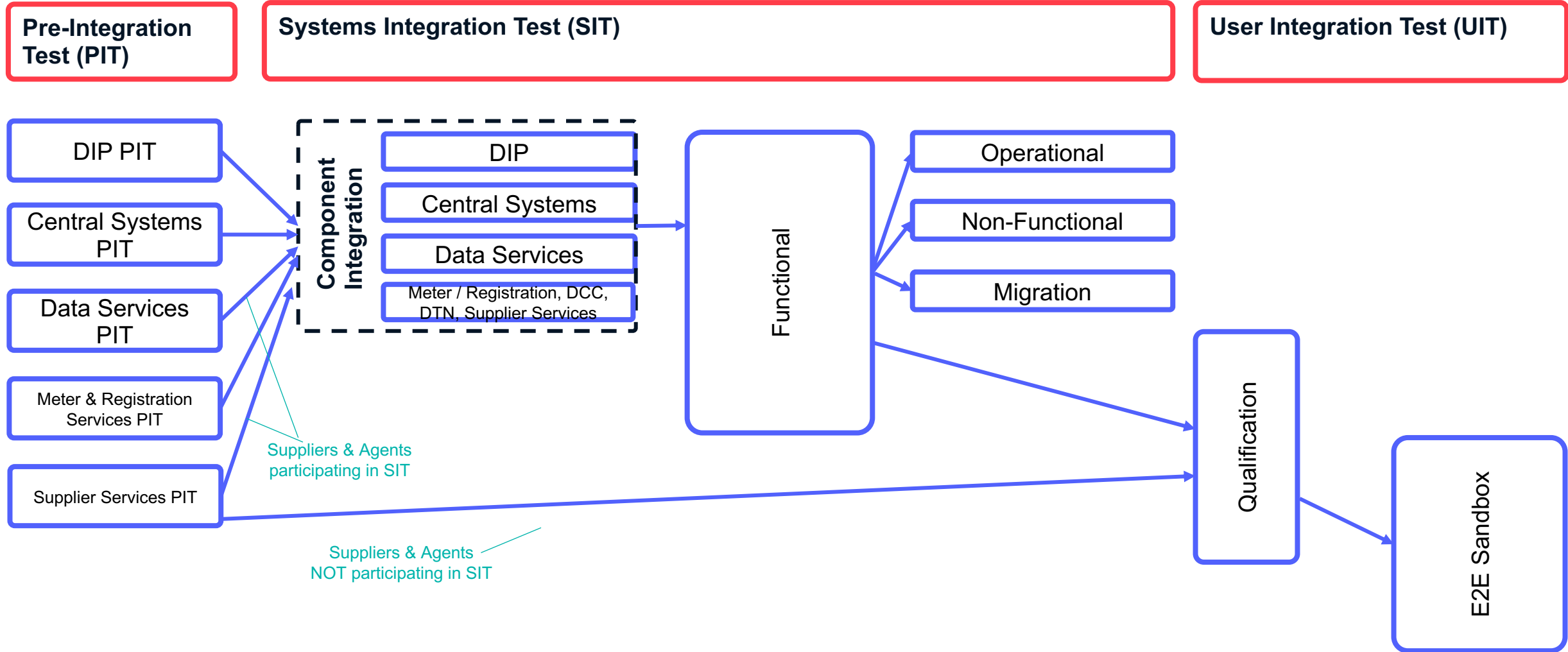

## Pre-Integration Testing (PIT)



### Who does PIT?

PIT will be performed by all users of the new Settlement Process to validate every system or service that is included in the E2E MHHS design (and its interfaces in/out) for compliance its functional and technical requirements. This includes back-office systems if affected.



### Who is responsible for PIT?

PIT is the responsibility of each individual party, using their own systems, test environments, test data, test artefacts (scenarios and scripts), test processes, test management tool and defect management process. The MHHS programme will provide central service simulators and a meter data generator.



### What does PIT comprise?

PIT will include functional, non-functional and regression testing. It will test core business processes, ensuring changes due to the implementation of the MHHS Programme have been implemented correctly (including interfaces to other systems within the scope of the MHHS TOM).



### How is PIT exited?

A MHHS Test Completion report will be provided by all participants to record the outcome of their PIT testing and will form part of the exit criteria from PIT and entry criteria for their next test phase. For most participants, this report will be brief but will be more detailed for those participants taking part in SIT (eg Elexon Central Systems or SIT-participating suppliers and agents).



### How is PIT assured?

Assurance of the PIT activities and evidence will be the responsibility of the MHHS IM and IPA. This is important to give confidence ahead of SIT.



### Who does SIT?

SIT will be performed by the service providers of the central systems (Elexon, Electralink, DIP operator, St Clements, DCC and other metering service providers) together with a small number of volunteer suppliers and supplier agents and the MHHS IM (SI team).



### Who is responsible for SIT?

The SI team is responsible for the timely and successful completion of SIT. In practice, this means the SI defines the test scenarios and data, orchestrates the running of the tests and manages defect resolution. The Test Data Strategy will give further details about test data in SIT and UIT. Each participant will be responsible for defining detailed test steps, the provision of their own test environments and the execution of their processes for SIT. Each will also be responsible for The SI will manage SIT using Azure DevOps (ADO, which is the Microsoft equivalent of Jira). All participants will be required to develop their test scripts and record their execution in ADO.



### What does SIT comprise?

SIT will include functional, non-functional, operational and migration testing. Each of these elements will have a set of regression tests to verify change/defect fixes. SIT will verify that interfaces between components and E2E processes operate as specified in the MHHS E2E Design. It will include negative tests.



### How is SIT exited?

A MHHS Test Completion report will be provided by the SI and this will need to be approved by the Level 3 governance body Testing Advisory Group (TAG), which is chaired by the SRO.



### How is SIT assured?

Internal assurance of the SIT activities and evidence will be the responsibility of the MHHS IM and the IPA will conduct independent assurance.



## User Integration Testing (UIT) - Qualification



### Who does Qualification?

Qualification must be performed by all participants (other than the central systems providers) who wish to participate in the market.



### Who is responsible for Qualification?

Each Programme participant is responsible for ensuring their successful completion of Qualification. The SI will specify the tests to be run (based on MHHS E2E Design) and will ensure the availability of relevant test harnesses, a test environment and appropriate data against which each PP can test. Each participant will be responsible for defining the detailed test steps and recording the test execution in ADO. The SI will also manage the schedule of testing, since it is unlikely that all participants will be able to test simultaneously.

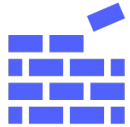

### What does Qualification comprise?

SIT proves the E2E design works through testing with parties; Qualification proves individual parties comply with the E2E design. Qualification will include functional and non-functional components as well as the ability to correctly perform the migration steps. It will verify that the participant's systems interact correctly with the central systems. It may contain an element of business process testing. A participant who successfully completes SIT will be deemed to have completed Qualification.



### How is Qualification exited?

A MHHS Test Completion report will be provided by each participant and this will need to be approved by the MHHS IM. Once a participant has successfully completed Qualification, they may use the E2E Sandbox for further testing.



### How is Qualification assured?

Assurance of individual participants will be as described above under "Qualification exit". In addition, the SI team will conduct selective assurance, as will the IPA.



### Who does E2E Sandbox testing?

E2E Sandbox testing is for all participants (other than the central systems providers) once they have completed Qualification.

---



### Who is responsible for E2E Sandbox testing?

Each Programme participant is responsible for their own E2E Sandbox testing, including defining the scenarios and scripts. The SI will ensure that a test environment and appropriate data are available to participants. The SI will manage the schedule of testing if necessary (to the extent of allocation of a participant to a test window) and the defect resolution process for any defects in the central systems.

---



### What does E2E Sandbox testing comprise?

E2E Sandbox testing can be any testing the participant wishes to undertake (with the exception of volume/performance testing). It allows a participant to thoroughly test their systems and business processes to the degree they deem appropriate. This is a crucial test stage – the participants each know their own businesses and because historically it has flushed out many important issues.

---



### How is E2E Sandbox exited?

There is no formal Programme exit for E2E Sandbox testing. Each participant should set their own exit criteria and measure whether they have been reached.

---



### How is E2E Sandbox testing assured?

Each participant is responsible for conducting their own assurance of E2E Sandbox testing.

## Test Process, management & organisation

	PIT		SIT (all stages)		UIT - Qualification		UIT – E2ET	
<b>Test basis</b>	PP technical documents & MHHS interface specs	PP	MHHS E2E Design	MHHS	Qualification Test Scope & E2E Design	MHHS	PP tech/BP docs & MHHS E2E Design	PP
<b>Test types</b>	F/NF/Regression		F/NF/Regression/Ops		F/NF/Regression		Any	
<b>Test scenarios</b>	PP own process	PP	In ADO	MHHS	In ADO	MHHS	PP own process	PP
<b>Test scripts (manual/auto)</b>	PP own process	PP	In ADO	MHHS	In ADO	PP	PP own process	PP
<b>Test data</b>	MHHS test harness available for PP data generation	PP	MHHS-specified	MHHS	PP given range of data by MHHS	MHHS & PP	MHHS test harness available for PP data generation	MHHS & PP
<b>Test execution</b>	PP own process	PP	MHHS IM-co-ordinated process	MHHS & PP	PP own process	PP	PP own process	PP
<b>Test management tool</b>	PP own tool	PP	ADO	MHHS & PP	ADO	PP	PP own tool	PP
<b>Issue &amp; Defect management</b>	PP own process	PP	ADO for MHHS issues PP own process	MHHS & PP	ADO for MHHS issues PP own process	MHHS & PP	ADO for MHHS issues PP own process	MHHS & PP
<b>Test completion report</b>	MHHS Programme format	PP	MHHS Programme format	MHHS	MHHS Programme format	PP	MHHS Programme format	PP
<b>Test assurance</b>	PP own process & MHHS IM assurance	PP MHHS	MHHS IM assurance Independent assurance	MHHS IPA	MHHS IM assurance Independent assurance	MHHS IPA	PP own process & MHHS IM assurance	PP MHHS
<b>Test exit approval</b>	PP own process	PP	MHHS process	MHHS TAG	MHHS process	MHHS	PP own process	PP

# Test Environments (for those participants taking part in SIT)

Note that a separate Environment & Configuration Management Approach & Plan will be produced and that high-level requirements for security testing of the environments.

**Pre-Integration Test (PIT)**

**Systems Integration Test (SIT)**

**User Integration Test (UIT)**

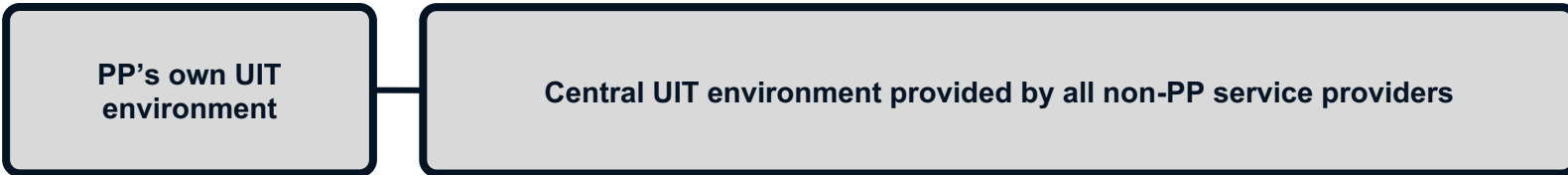
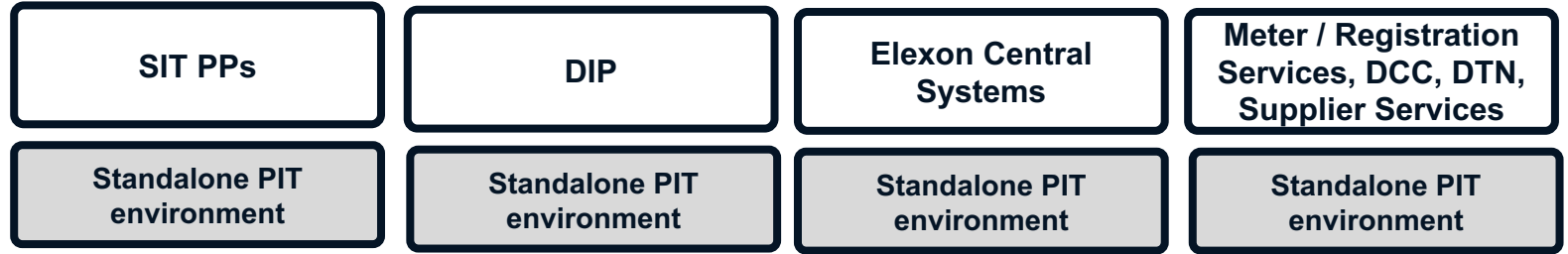
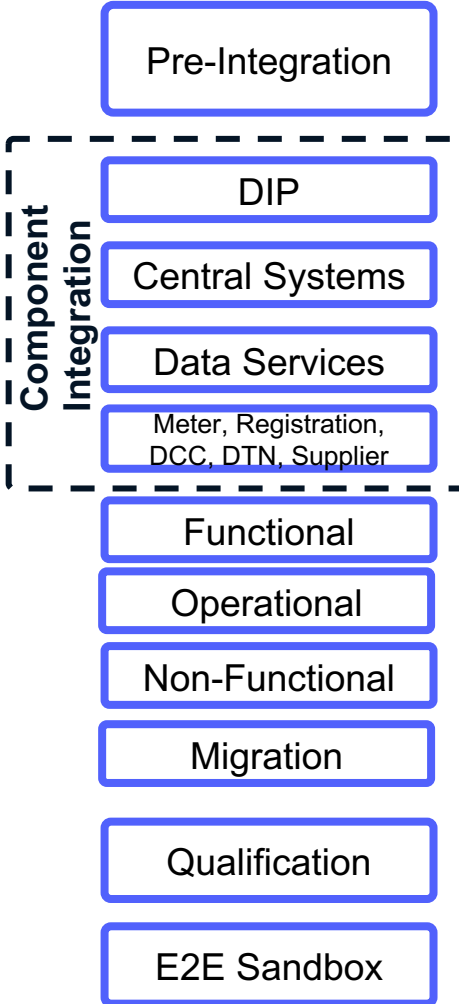

# Test Environments - Programme Participants (not in SIT)

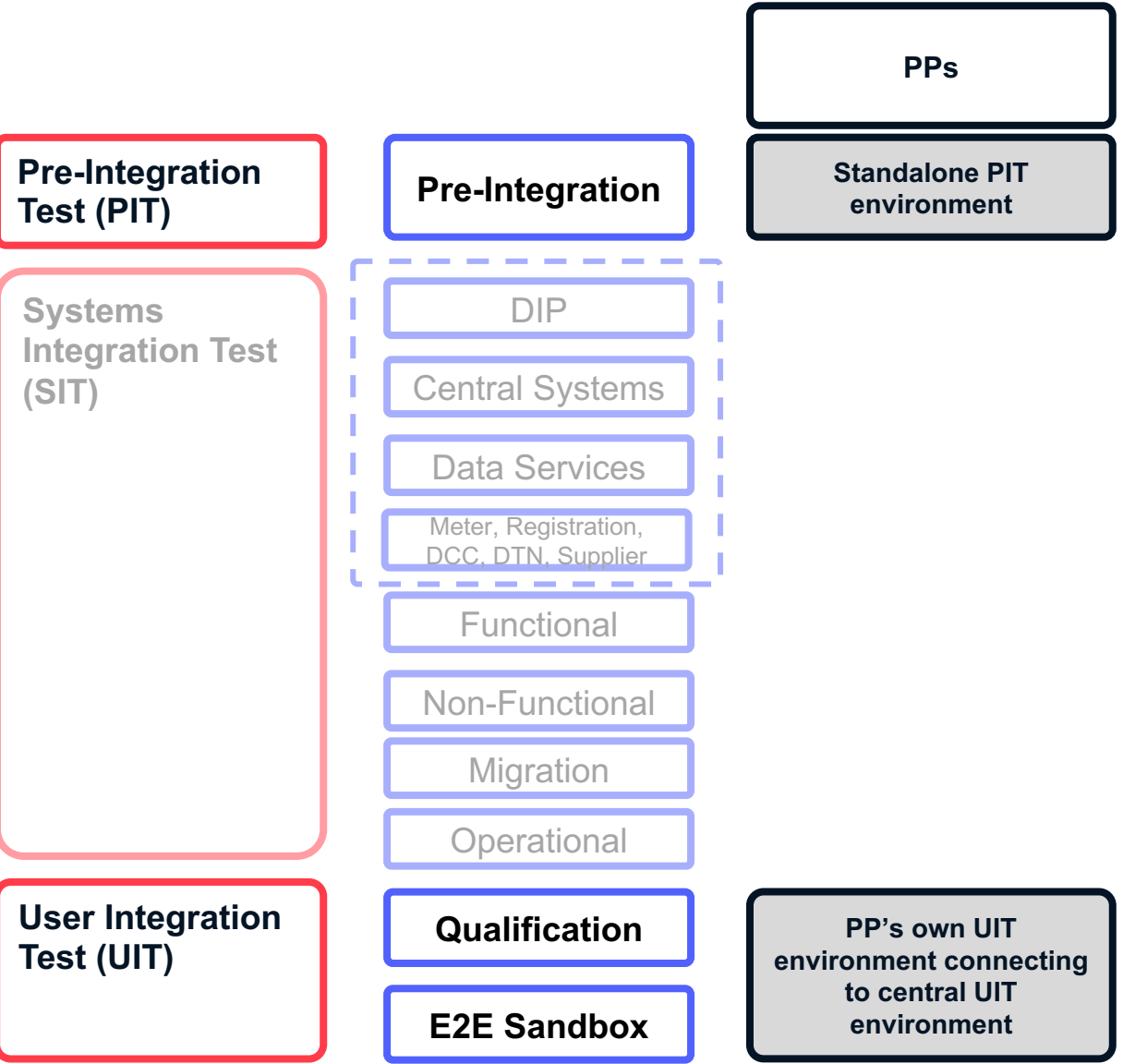

**Discussion point**

What are the requirements in BAU?  
 There will potentially be the need for additional environments once the settlement arrangements are live because of the need to be able to support emergency patches at the same time as major new releases

# Simulators, Emulators and Data-Generation Test Harnesses provided by MHHS IM

Phase	Stage	Test harnesses used to support test execution*	Provided by
Pre-Integration Test (PIT)	Pre-Integration	LSS Simulator, MDS Simulator, Meter Data Generator	MHHS IM
Systems Integration Test (SIT)	DIP	n/a	n/a
	Central Systems	Settlement Period Data Generator	MHHS IM
	Data Services	Meter Data Generator	MHHS IM
	Meter, Registration, DCC, DTN, Supplier	n/a	n/a
	Functional	SDS Emulator, ARP Emulator, UMSDS Emulator	MHHS IM
	Operational	SDS Emulator, ARP Emulator, UMSDS Emulator	MHHS IM
	Non-Functional	SDS Emulator, ARP Emulator, UMSDS Emulator, NF Settlement Period Data Generator	MHHS IM
	Migration	SDS Emulator, ARP Emulator, UMSDS Emulator	MHHS IM
	Qualification	Meter Data Generator, SDS Emulator, ARP Emulator, UMSDS Emulator	MHHS IM
	E2E Sandbox	Meter Data Generator, SDS Emulator, ARP Emulator, UMSDS Emulator	MHHS IM
User Integration Test (UIT)	Qualification	Meter Data Generator, SDS Emulator, ARP Emulator, UMSDS Emulator	MHHS IM
	E2E Sandbox	Meter Data Generator, SDS Emulator, ARP Emulator, UMSDS Emulator	MHHS IM

Component Integration

\* test management tool considerations not included

# Simulators, Emulators and Data-Generation Test Harnesses supplied by PPs

Phase	Stage	Test harnesses used to support test execution*	Provided by
Pre-Integration Test (PIT)	Pre-Integration	Meter data injector	PP
Systems Integration Test (SIT)	DIP	DIP test harness	DIP provider
	Central Systems	DIP test harness	DIP provider
	Data Services	Meter data injector	PP
	Meter, Registration, DCC, DTN, Supplier	n/a	n/a
	Functional	n/a	n/a
	Operational	n/a	n/a
	Non-Functional	n/a	n/a
	Migration	n/a	n/a
	Qualification	Meter data injector	PP
	E2E Sandbox	Meter data injector	PP

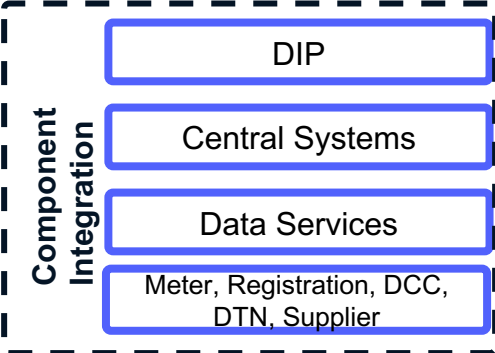

\* test management tool considerations not included

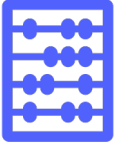

### Test Harnesses for Pre-Integration Testing

**LSS Simulator** - (for standalone PIT use by PPs - when they are running tests independently on their own infrastructure; probably cloud-based and accessible to all PPs) creates and receives information in the right way but has no underlying business functionality (or very little); will be used in conjunction with the test facilities delivered by the supplier of the DIP solution

**MDS Simulator** – as for LSS

**Meter Data Generator** –generates test data (suitable for consumption by SDS, ARP & UMSSDS) which the PPs can use in conjunction with their own existing simulators (for PIT)

Developed in time for the PPs to use in their own testing.



### Data Generators for SIT

**Settlement Period Data Generator** –generates test data (suitable for consumption by the Elexon Central Systems); configurable for SDS, ARP or UMSSDS data provision (question – is this already a deliverable of Elexon Central Systems?)

(**Non-Functional Settlement Period Data Generator** if it is more appropriate to have a separate one

Developed in time for use in SIT).



### Automated Test Results Generators for SIT/UIT (Emulators)

**SDS Emulator** - hosted by MHHS IM on Azure Cloud; takes as input the test data which enters SDS and produces the result expected from SDS; then compares the actual SDS result with the result the emulator has calculated itself and reports on test success or failure; significant diagnostics will be needed to allow testers to determine the source of the error where the test results do not match

**ARP Emulator** – as SDS, but for ARP

**UMSSDS Emulator**– as SDS, but for UMSSDS

Developed in time for use in appropriate part of SIT.



# Component Integration - Progressive Integration

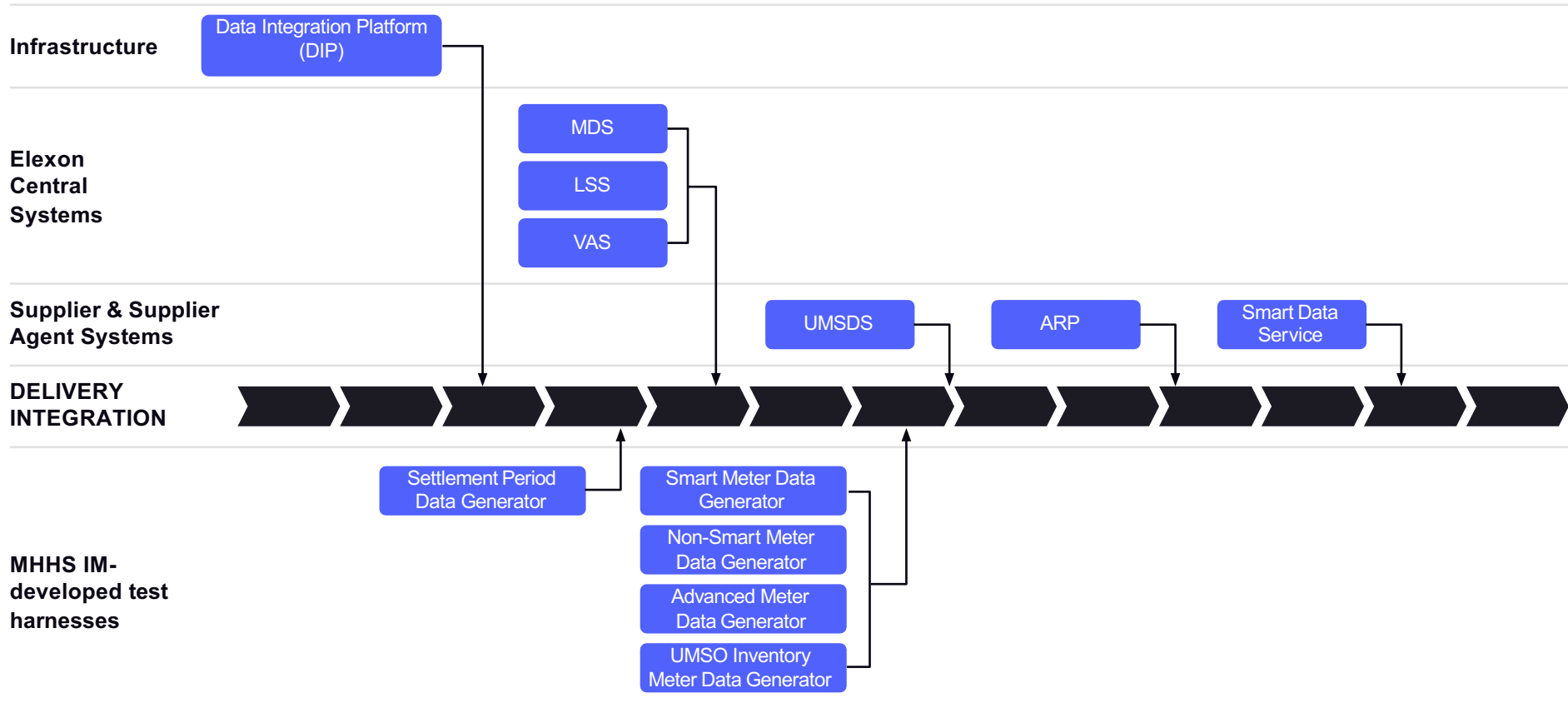



### Governance Groups

The Level 3 governance group responsible for testing is the Test Advisory Group (TAG). TAG will stand up Level 4 Working Groups for different aspects of the testing at appropriate points in the programme. The list of L4 groups is likely to be:

- Migration Working Group (being stood up in April)
- Data Working Group (being stood up in March)
- Qualification & E2E Sandbox Working Group
- Non-Functional Testing Working Group
- SIT Working Group



### Approvals

TAG will be responsible for supporting the development, reviewing and approving the E2E Integration & Testing Strategy. An Approach & Plan document will then be produced for each Stage in conjunction with the relevant L4 Working Group. The Working Group will also review and make a recommendation for approval. The recommendation will go to TAG for ratification. TAG will be responsible for approving the entry and exit for each Test Stage within SIT.



### Assurance activities

Assurance activities will be performed throughout the life of the MHHS Programme.

---



### IPA

Ofgem have appointed PwC as the Independent Assurance Provider (IPA) for the MHHS Programme and they will perform assurance activities across all programme participants.

---



### MHHS IM assurance

The SI team within MHHS IM will perform assurance activities with regard to readiness and test progress, with support from the PPC team when required, across all Programme Participants (PPs).

---



### Types of assurance

The SI will perform a range of assurance activities across design, test preparation, test readiness, test execution, test exit and test traceability.

---



### Independence of assurance

In addition to each part of the programme conducting its own self-assurance, independence of assurance will be provided by:

- QA team assuring the activities of the SI
- SI assuring the activities of the PPs
- IPA providing overall independent assurance.



### Approach

The issue and defect management approach for the Programme will be documented in MHHS Issue & Defect Management Plan and will be used to manage all MHHS Programme issues and defects.



### MHHS Issue & Defect Management Plan

The MHHS Issue and Defect Management Plan will define the issue and defect management:

- Purpose and Scope
- Process
- Roles and Responsibilities
- Tool
- Governance
- Reporting.



### Responsibilities

Participants will be expected to manage their own issues and defects in PIT. The MHHS Issue & Defect Management Plan will be used for all subsequent test phases. In these phases, the issues will be managed by the SI using ADO. If a testing issue results in a defect being raised, the responsible service provider will own and track that defect to resolution at which point the SI will be responsible for co-ordinating any regression/other testing needed on the SIT or UIT environment.

# Defect Process Diagram

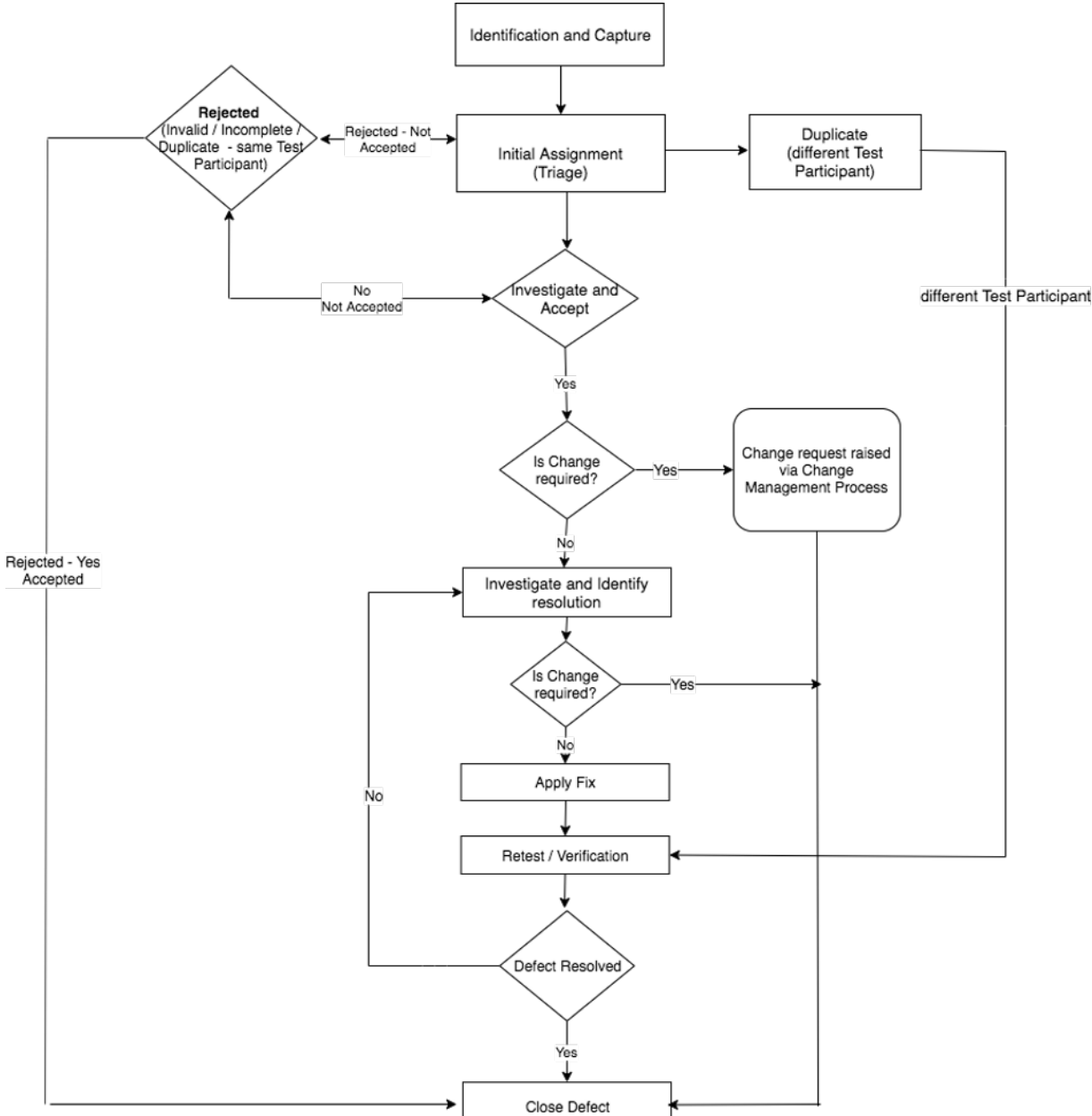

# E2E Test Data Strategy

Update from DWG on the timelines for Data Strategy development and sign off (action TAG 02-08) (discussion)

Kate Goodman/Adrian Ackroyd

*10 mins*

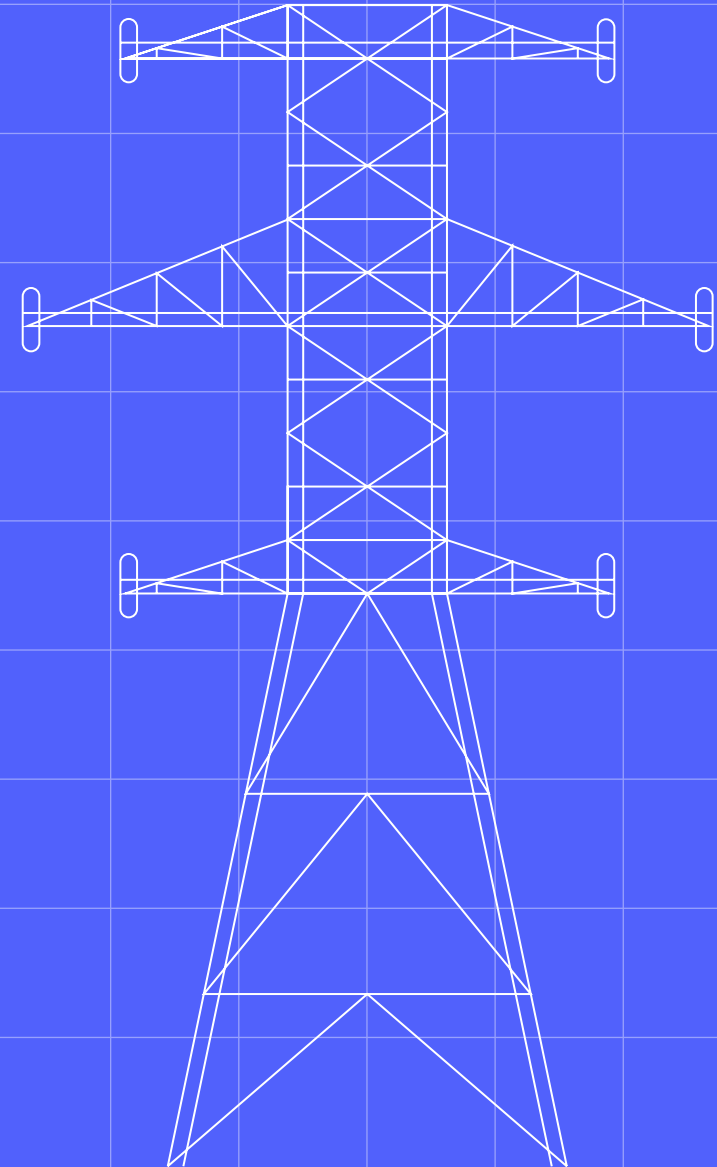

# Plan for development of Test Data Strategy

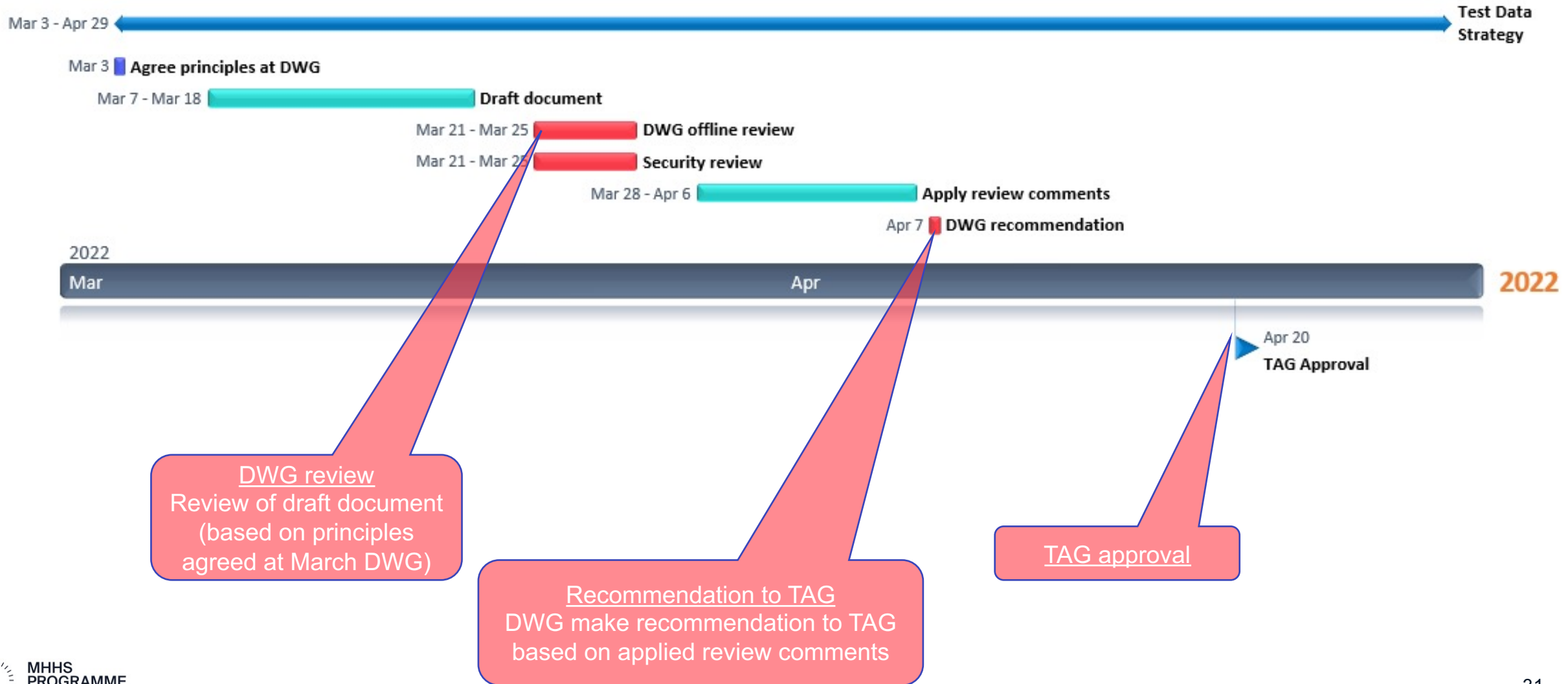

To agree the integration & testing strategy as described in these slides

- Scope
- Phases & stages
- Governance
- Test harnesses
- Environments
- Management & organisation
- Assurance
- Defect management

...and as amended by the agreements reached in the TAG meeting

- List of changes agreed



# Summary and next Steps

Summarise actions and plan agenda for next meeting  
(information)

Chris Welby

*5 mins*

## Next Steps

### Next steps:

- Confirm Actions from meeting
- Date of next TAG: 20<sup>th</sup> April 2022

### TAG Agenda Roadmap – a rolling six month view of upcoming TAG agenda items:

Meeting dates	16-Mar	20-Apr	18-May	22-Jun	27-Jul	24-Aug
Relevant milestone or activities			M5		M5+	
Agenda items	<ul style="list-style-type: none"> <li>• E2E Test strategy review</li> <li>• E2E Test Data strategy review</li> <li>• Migration and MWG</li> <li>• Data WG ToR</li> <li>• TMAG ToR</li> </ul>	<ul style="list-style-type: none"> <li>• E2E Test strategy approval</li> <li>• E2E Test Data strategy approval</li> <li>• Data Plan for Ind-Wide test approval (as part of E2E strategies above)</li> </ul>	<ul style="list-style-type: none"> <li>• Test tools strategy approval</li> <li>• Qualification principles</li> <li>• Migration strategy principles</li> </ul>	<ul style="list-style-type: none"> <li>• Test tools design</li> <li>• Migration strategy review</li> </ul>	<ul style="list-style-type: none"> <li>• Test tools design approval</li> <li>• Migration strategy approval</li> </ul>	<ul style="list-style-type: none"> <li>• SIT test approach and plan</li> <li>• Environment plan</li> </ul>
Standing items	<ul style="list-style-type: none"> <li>• Minutes &amp; actions</li> <li>• Agenda roadmap</li> <li>• Artefact sign-posting</li> </ul>	<ul style="list-style-type: none"> <li>• Minutes &amp; actions</li> <li>• Agenda roadmap</li> <li>• Artefact sign-posting</li> <li>• Working group highlight report</li> </ul>	<ul style="list-style-type: none"> <li>• Minutes &amp; actions</li> <li>• Agenda roadmap</li> <li>• Artefact sign-posting</li> <li>• Working group highlight report</li> </ul>	<ul style="list-style-type: none"> <li>• Minutes &amp; actions</li> <li>• Agenda roadmap</li> <li>• Artefact sign-posting</li> <li>• Working group highlight report</li> </ul>	<ul style="list-style-type: none"> <li>• Minutes &amp; actions</li> <li>• Agenda roadmap</li> <li>• Artefact sign-posting</li> <li>• Working group highlight report</li> </ul>	<ul style="list-style-type: none"> <li>• Minutes &amp; actions</li> <li>• Agenda roadmap</li> <li>• Artefact sign-posting</li> <li>• Working group highlight report</li> </ul>

If you would like to propose an agenda item for TAG, please contact the PMO

# Thank you